

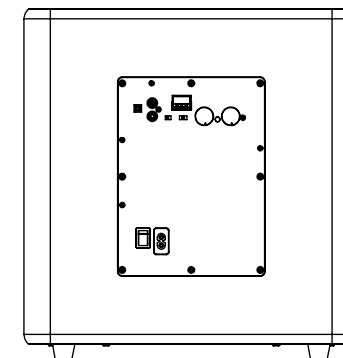

FRONT

SIDE

BACK

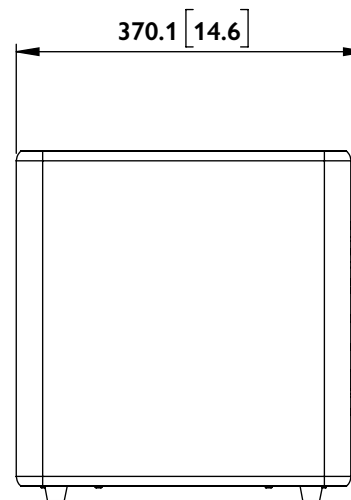
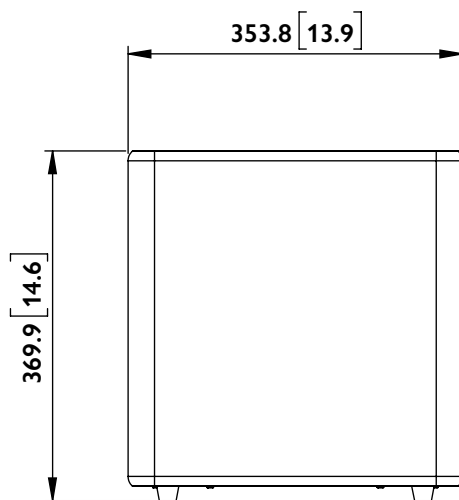
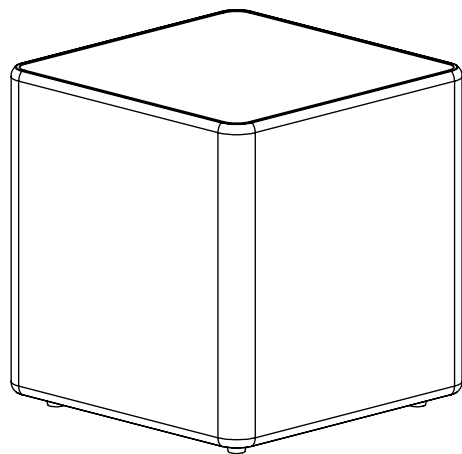

BOTTOM

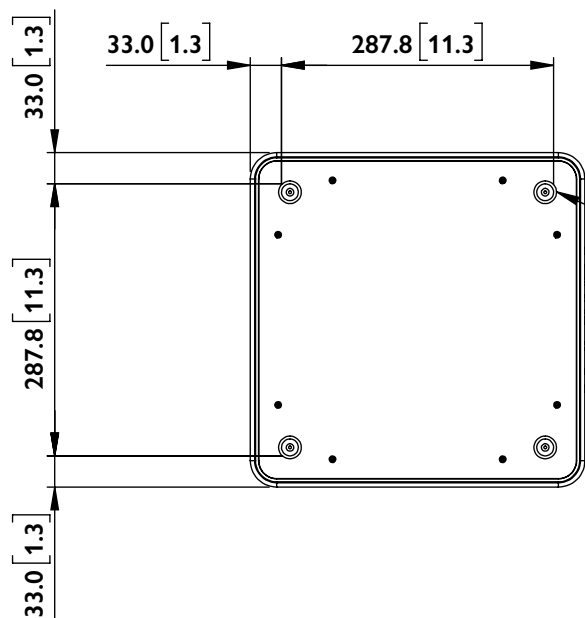

Feet thread size:
M3 x pitch 0.5

Kube 10b

UNIT: MM [INCH]